

Updated date : 2014.02.04

Model : RGB-LE-V3.1 / Product code : RB-100126-013

W220+RGB-LE

Specification & Installation



SUNE TECHNOLOGY ELECTRONIC CO., LTD No.9, Land 606,Anping
Rd., Tainan City 70849 Taiwan
Tel: +886-62292246 Fax:+886-62288104
Website <http://www.sune-tech.com>
Shop <http://www.carnavi-tech.com>
Skype : hsin_han99 or sune_tech

Contents

1. Before installation

1.1 Main specification -----	3
1.2 System diagram-----	4
1.3 Components-----	5
1.4 Exterior -----	6

2. Setup

2.1 DIP switch-----	7
2.2 Remote controller -----	8
2.3 Power cable wiring diagram -----	9

3. Installation

3.1 Installation diagram -----	10
3.2 Cautions on installation -----	11
3.3 Installation-----	12

4. Troubleshooting -----	13
--------------------------	----

1.1 Main Specification

1. Input Spec. (MULTI VIDEO INTERFACE)

- 2 x CVBS Input (External video source).
- 1 x CVBS (REAR CAMERA) Input (Rear camera source)
- 1 x Analog RGB Input (Car commander original monitor output)
- 1 x Analog RGB Input (Navigation System output)-→OPTION

2. Output Spec.

- 1 x CVBS OUTPUT (Video Out for installing Headrest monitor)
- 1 x RGB OUTPUT(LCD Operation)
- 1 x Audio Select OUTPUT (For operating A/V sources – (ex) 12V is come out on V1 port, when AV1 is chosen.)

3. Power Spec.

- Input Power : 8VDC ~ 18VDC
- Consumption Power : 5WATT, Max

4. Switch Input mode

- NAVI/CVBS1,2 Original MUTE Function : Possible to mute each input by operating Dip S/W
- Possible to switch Input mode with remote control or toggle switch.
- Rear View Camera mode : When to sense rear gear power, be switched to Rear view camera mode (Impossible to switch to rear mode with Toggle S/W or the Remote control)

1.2 System Diagram

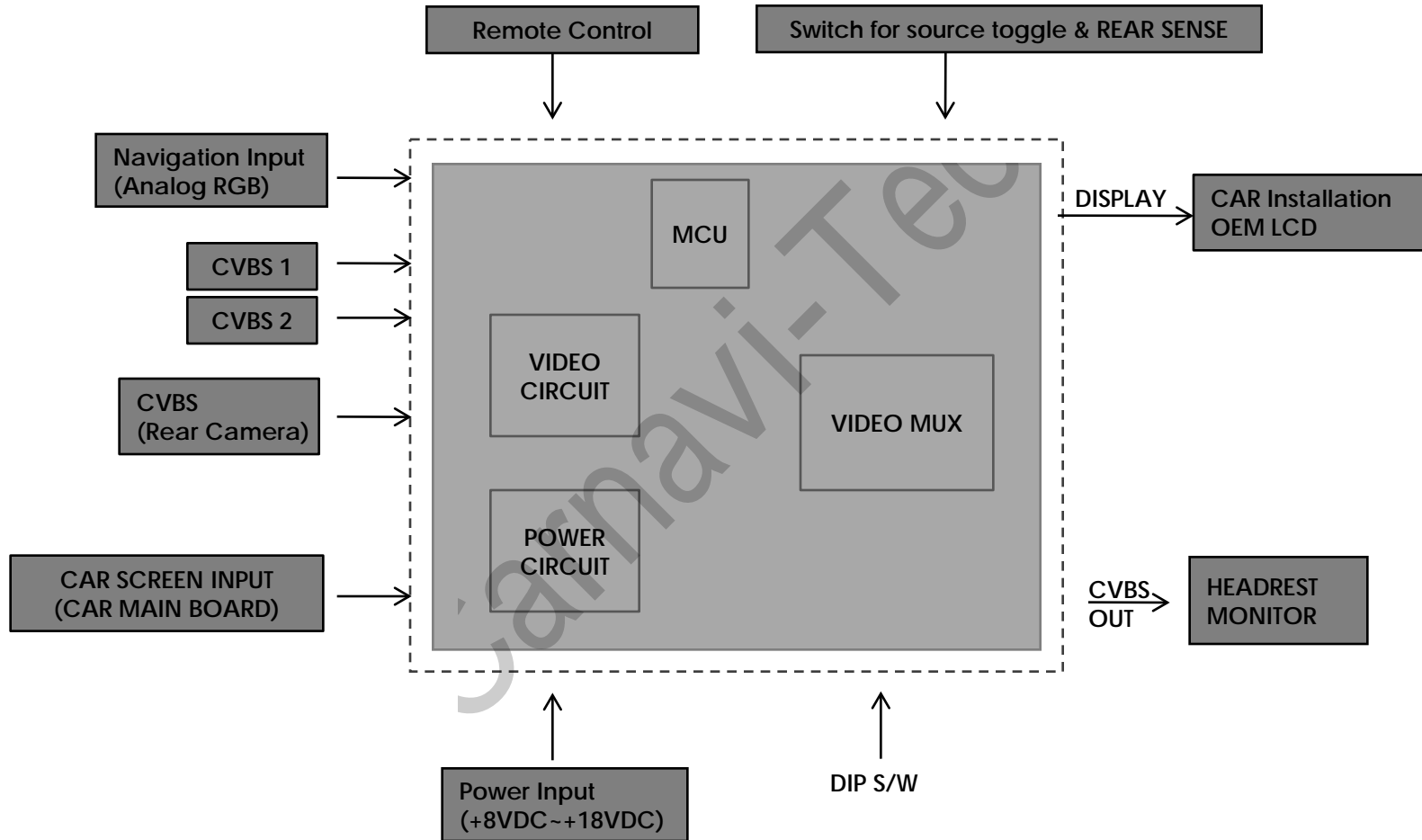

1.3 Components

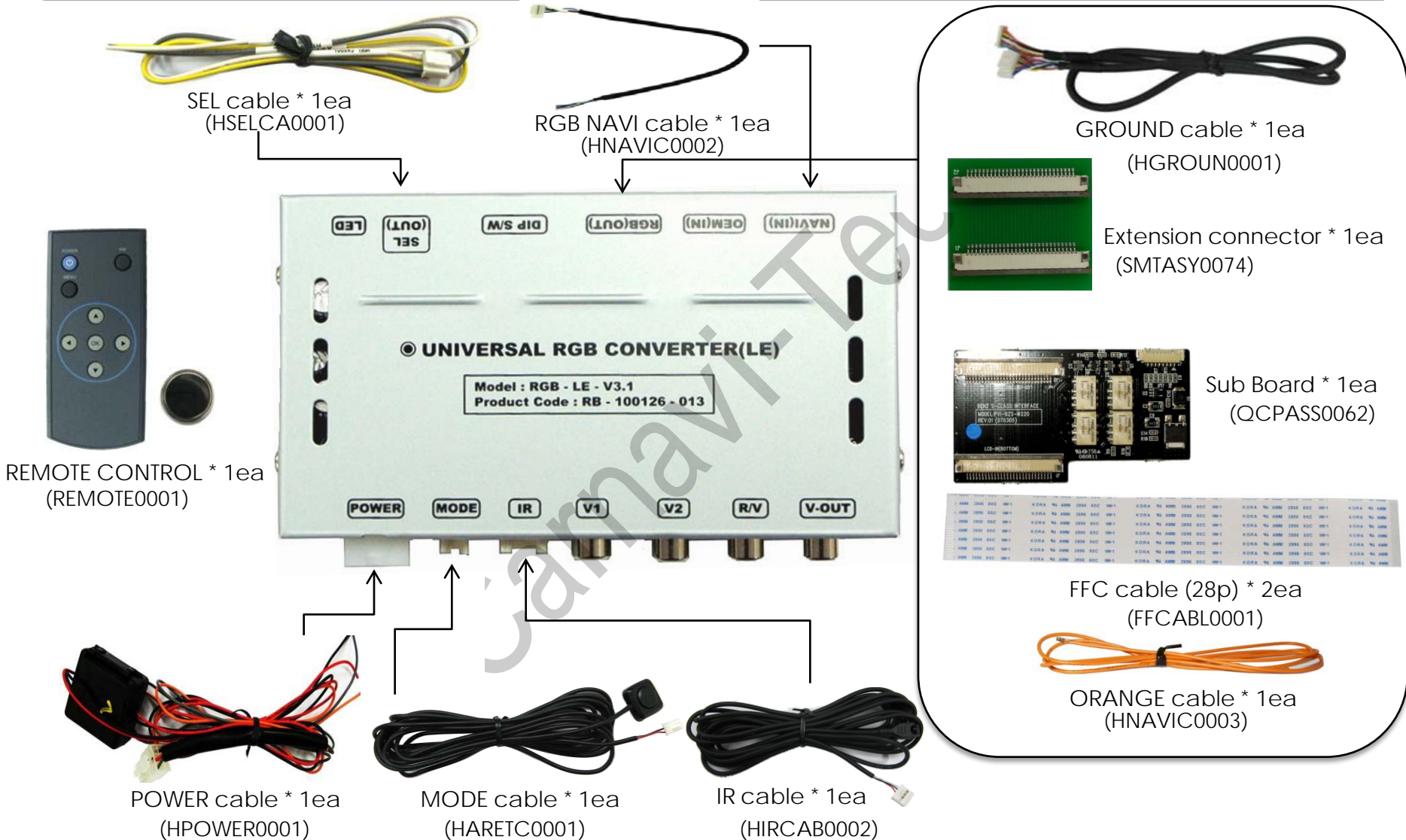

1.4 Exterior

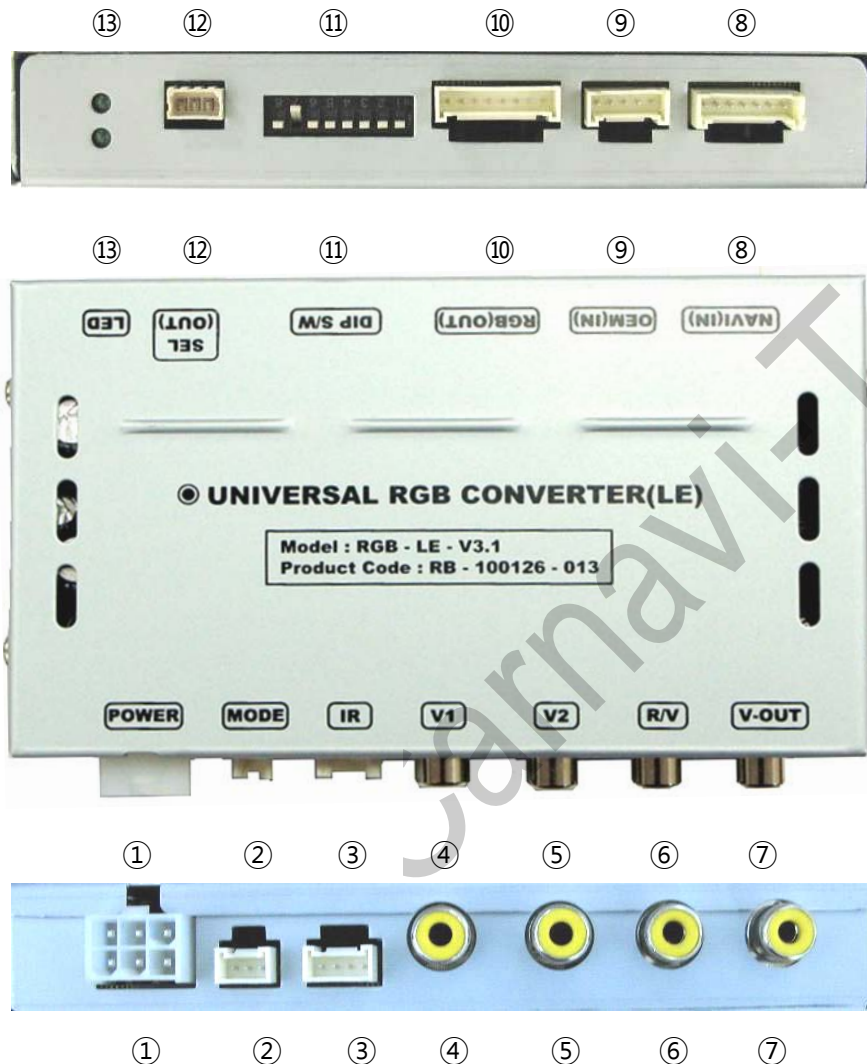

Dimension

Horizontal length 129mm
 Vertical length 75mm
 Height 21mm

- ① POWER
- ② MODE
- ③ IR
- ④ V1
- ⑤ V2
- ⑥ R/V
- ⑦ V-OUT
- ⑧ NAVI (IN)
- ⑨ OEM (IN)
- ⑩ RGB OUT
- ⑪ DIP S/W
- ⑫ AUDIO-SEL
- ⑬ LED

2.1 DIP switch

#PIN	Function	DIP S/W selection
1	RGB INPUT skip	ON : Skipping RGB Mode OFF : RGB Display
2	CVBS1 MUTE	ON : Skipping CVBS1 OFF : CVBS1 Display
3	CVBS2 MUTE	ON : Skipping CVBS2 OFF : CVBS2 Display
4	CAN	ON : When install to the Cayenne OFF : When install to all of the car
5	OEM MUTE	ON : Skipping OEM OFF : OEM Display
6	INTERLACE	ON : Non-Interlace OFF : Interlace
7	REAR MODE	ON : External Rear Camera OFF : OEM Rear Camera
8	SYNC ON GREEN	ON : Sync On Green (RGSB) OFF : Sync On Green Off

※DIP S/W Use Example

[W220]

- Use Input Mode : CVBS1, Navigation (RGB), Main
- Rear Camera : When to be installed on CVBS 4

- ▷ DIP S/W : 1 → OFF
- ▷ DIP S/W : 2 → OFF
- ▷ DIP S/W : 3 → ON
- ▷ DIP S/W : 4 → OFF (All of the Car except Cayenne)
- ▷ DIP S/W : 5 → OFF
- ▷ DIP S/W : 6 → OFF
- ▷ DIP S/W : 7 → ON (enable CVBS4)
- ▷ DIP S/W : 8 → OFF



* Caution

- If the displayed screen vibrates, please try to operate Dip S/W No. 6 after turning power off.

2.2 Remote controller

Key	Function
POWER & PIP	Not for use
MENU	OSD implementation
OK	Making a selection
▲	Move upward
▼	Move downward
◀	Move leftward, press 2 seconds long-Factory mode implementation
▶	Move rightward, press 2 seconds long-Factory Mode implementation-Factory mode Reset



SIZE : 85 * 40 * 8 (mm)

2.3 Power cable wiring diagram

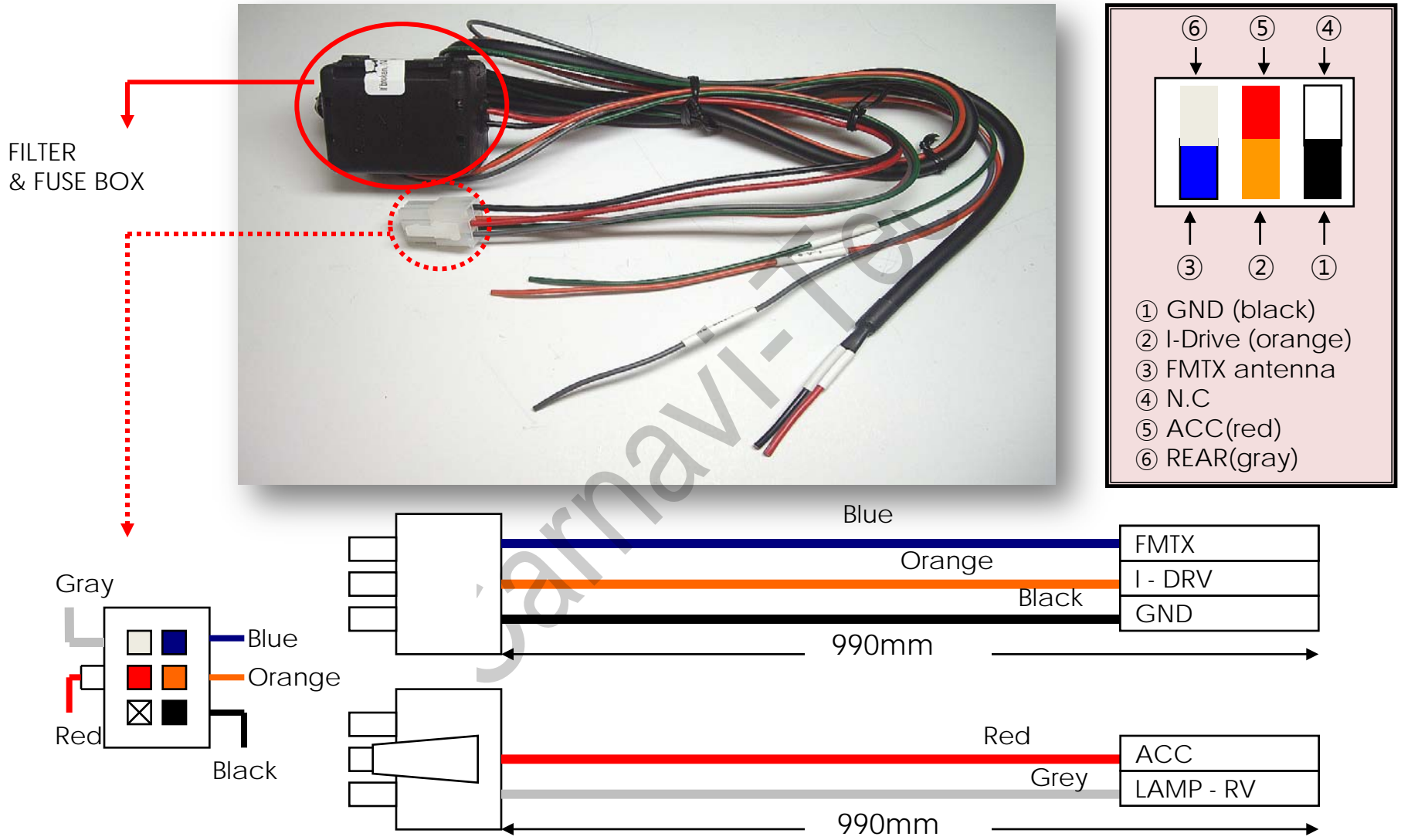

3.1 Cautions on installation

- Ignition key should be taken off before starting installation, interface power connection must be the last step in installation.
- Power cable should be separated when connecting interface.
- Should be no any electronic devices or magnetic pole around installation place.
- All steps of installation should be done by well-trained specialist.
- Dismantling without manufacturer's permission can not be guaranteed, (No permission to break attached label on the board.)
- Kindly check all parts are in the box, when receiving the product, if anything missing, inform to the supplier or manufacturer.
- According to our sales policy, any problems caused by user's mistake, careless can not be guaranteed.

3.2 Installation diagram

※ Please make sure that the installation should be carefully conducted to avoid from the damage of a monitor by ESD(Electrostatic discharge) and misalignment while connecting the module of a monitor with cables.

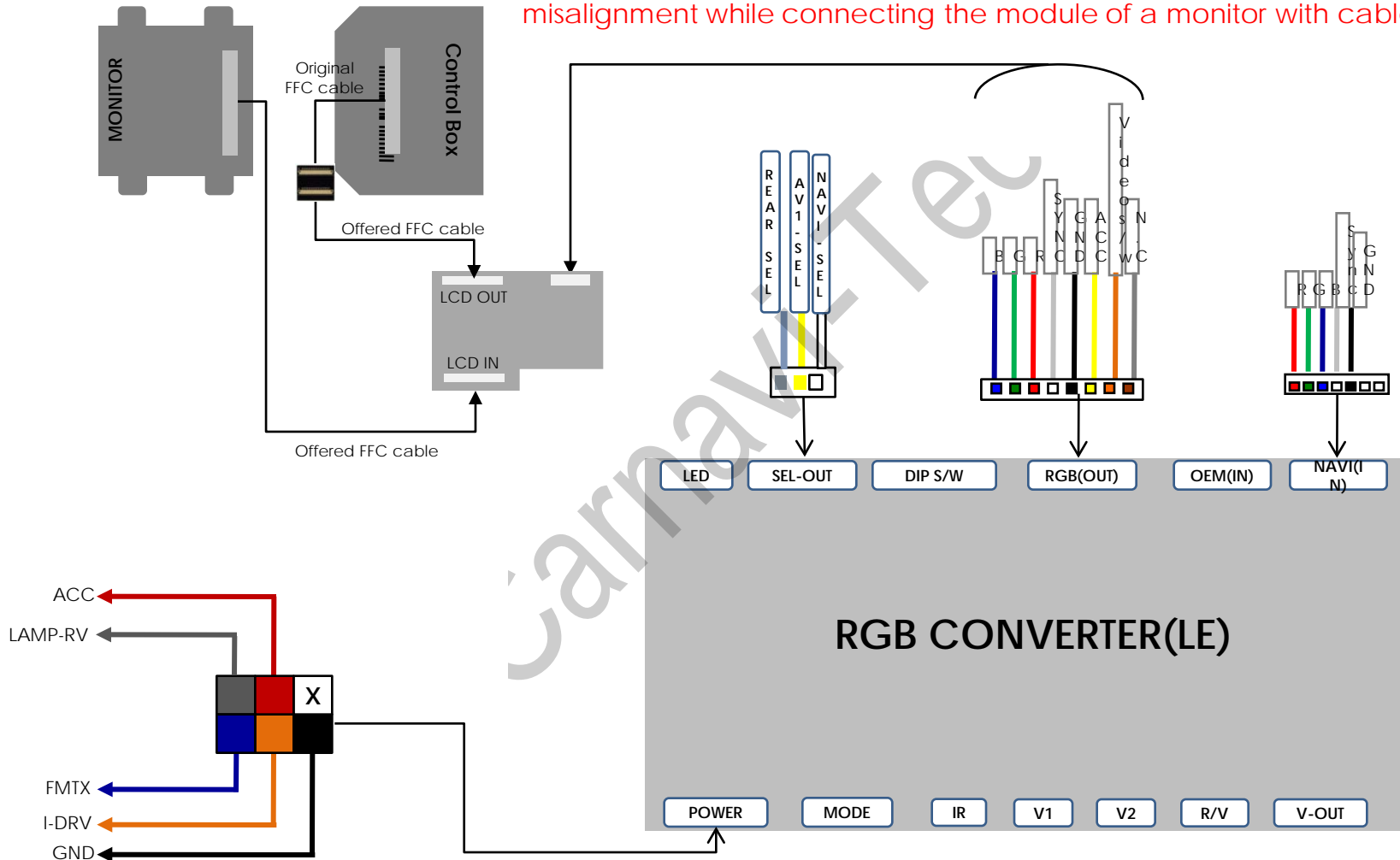

3.3 Installation

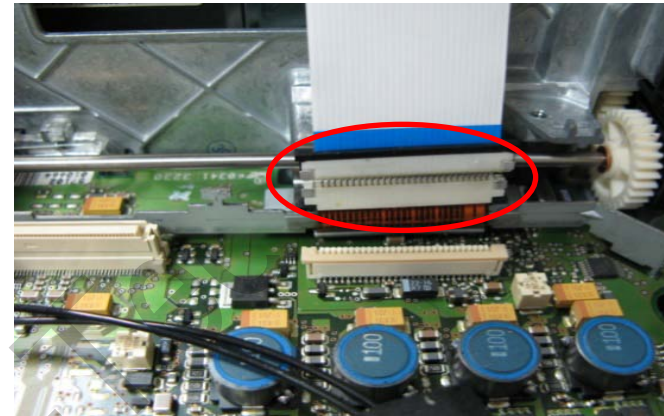
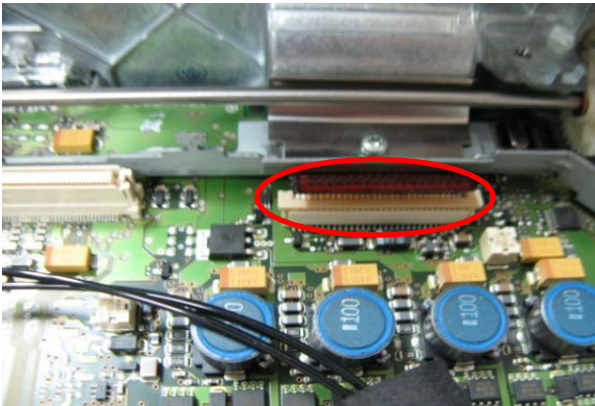

1. After pulling out original FFC cable from back of the monitor, connect with extension connector. And offered FFC cable connect with the other side of the extension connector. (The other side of offered FFC cable connect with offered sub-board "LCD OUT")

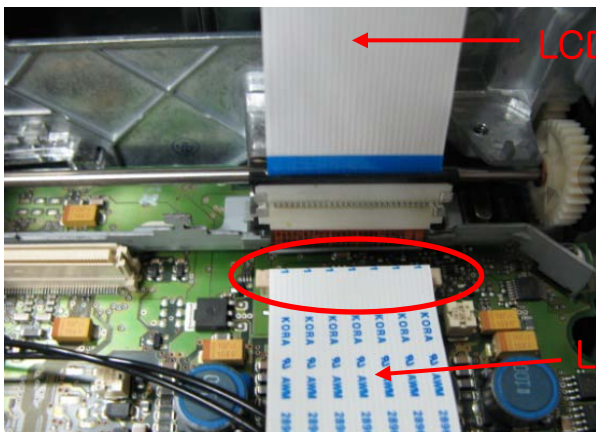

2. The connector which is pulled out the original FFC cable connect with second offered FFC cable. (The other side of second offered FFC cable connect with offered sub-board "LCD IN")

3.3 Installation



3. The finished photo is the same as above.

Jarnavi-Tec

4. Troubleshooting

Q. I can not switch A/V sources.

A. Check IR or Ground cable connection. Check LED lamps in the interface, if it is not on, check power cable.

Q. All I got on the screen is black.

A. Check second LED lamp of the interface is on, if not, check A/V sources connected are working well.

(Second lamp indicates AV sources connected works well.) Check interface connection has been done well.

Q. Displayed image color is not proper. (too dim or not suitable color)

A. Try to select "INITIAL" in OSD menu, if it does not work, inform the manufacturer.)

Q. Rear camera image does NOT appear.

A. Set DIP switch #7 in "ON"

Q. Unwanted A/V mode is displayed. (A/V source switching order : OEM->RGB->AV1->AV2->AV3)

A. Check DIP Switch Setting.

Q. OEM image is not displayed.

A. Check interface's LCD In/Out cable connection. If the status keeps on, inform the manufacturer.

Q. Screen only displays white like left picture.

A. Check LCD out cable is connected well, if this status keeps, inform the manufacturer.